

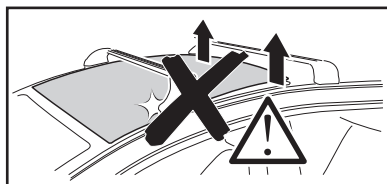

Thule Rapid System Kit 4088 Thule Podium Kit 4088

> Instructions

LAND ROVER Range Rover Velar, 5-dr SUV, 17-



This kit is only for vehicles with flush side railing.

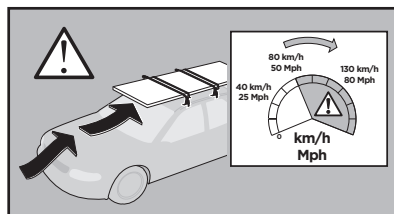
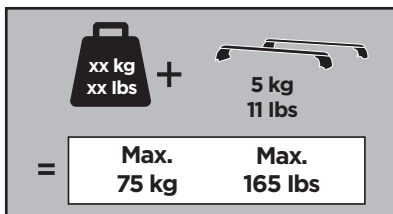
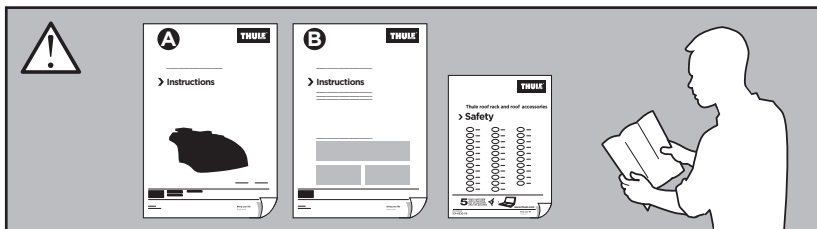

ISO 11154-E

184088

C.20170930
509-4088-01

Bring your life
thule.com

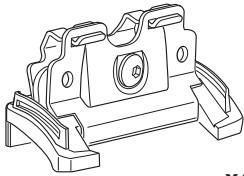

x4

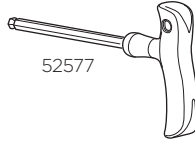

x1

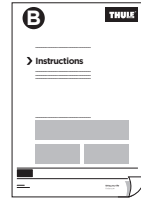

x1

1

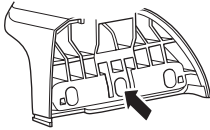

Thule Rapid System Foot Pack 753/7531 Thule Podium Foot Pack 460/460R

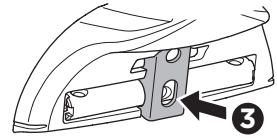
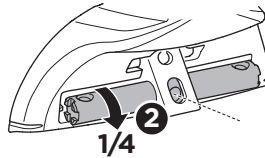
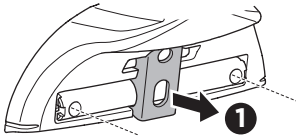

2

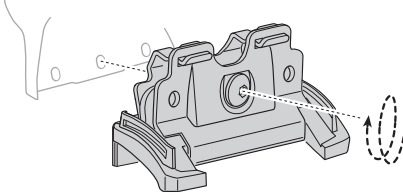

- EN** Only a few turns
- DE** Nur wenige Umdrehungen
- FR** Quelques tours uniquement
- NL** Slechts enkele slagen
- IT** Solo qualche giro
- ES** Sólo algunas vueltas
- PT** Apenas algumas voltas
- SV** Endast några varv
- DK** Kun nogle få omgange
- NO** Bare noen få omdreininger
- FI** Vain muutama kierros

- ET** Ainult mõni pööre
- LV** Tikai daži apgriezieni
- LT** Tik keli pasukimai
- PL** Wystarczy kilka obrotów
- RU** Только несколько оборотов
- UK** Лише декілька обертів
- BG** Само няколко завъртания
- CS** Pouze několik otáček
- SK** Len niekoľko otáčok
- SL** Le nekaj obratov
- HR/BiH** Samo nekoliko okreta
- RO** Doar câteva rotiri
- HU** Csak néhány fordítás
- EL** Μόνο λίγες περιστροφές
- TR** Yalnızca birkaç tur

بعض دورات فقط

רק מספר סיבובים

AR

HE

- ZH** 仅几圈
- JA** 2～3回転のみ
- KO** 몇 번만 돌리면 됨
- TH** เพียงสองสามรอบ

3

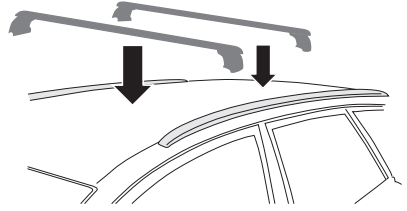
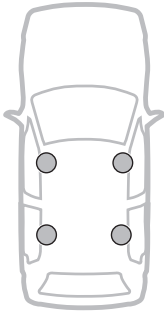

4

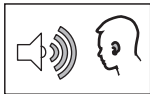
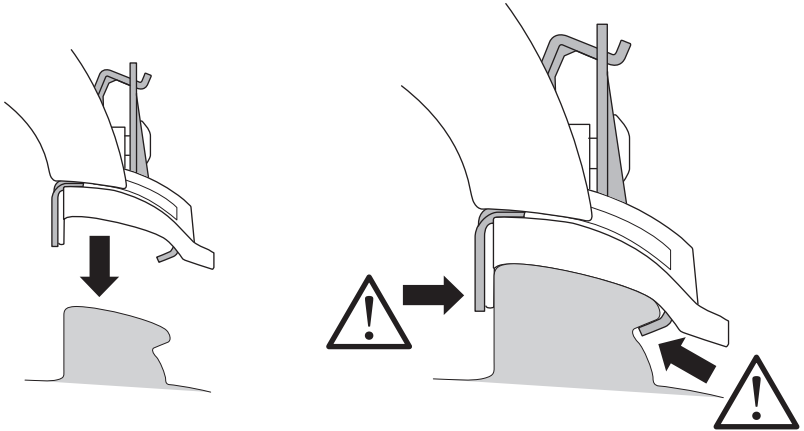

~ 700 mm

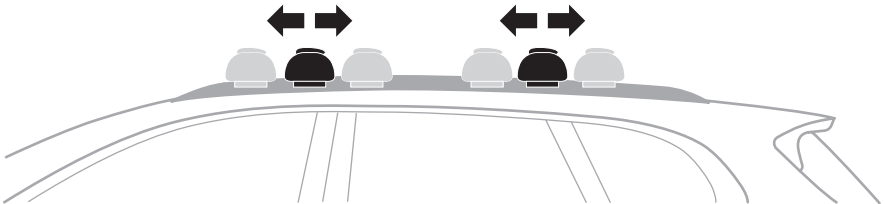
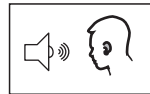

5

- | | | | |
|-----------|---|---------------|---|
| EN | Tighten alternately | UK | Затягти по чергово |
| DE | Die Schrauben abwechselnd anziehen | BG | Затегнете последователно |
| FR | Serrer alternativement chaque côté | CS | Pokřetla багаžnika dokřečaj dokřečaj naprzemiennie. |
| NL | Afwisselend aan de linker- en de rechterkant aandraaien | SK | Dotahujte striedavo |
| IT | Alternare il serraggio delle viti | SL | Privijajte izmenično |
| ES | Apretar alternativamente | HR/BiH | Naizmjenično zategnite |
| PT | Aperte alternadamente | RO | Strângeți alternativ |
| SV | Dra åt växelvis | HU | Egy mástól függetlenül szorítandó |
| DK | Spænd skiftevis | EL | Σφίγγετε εναλλάξ |
| NO | Trekk til vekselvis | TR | Dönüşümlü sıkın |
| FI | Kierrä vuorotellen | | إحكام الربط بالتناوب AR |
| ET | Pinguldage vaheldumisi | | חזק לסימון HE |
| LV | Pievelciet pamīšus | ZH | 交替拧紧 |
| LT | Užsukinėkite pakaitomis | JA | 左右交互に締めつけてください |
| PL | Śruby dokręcaj naprzemiennie | KO | 번갈아 조이기 |
| RU | Затягивайте попеременно | TH | ข้ามในแบบสลับ |

